

EXH Series Compact Slide Cylinder

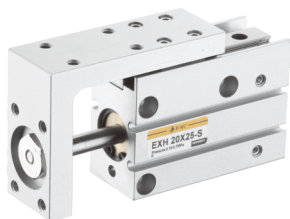

EXH

Compact Slide Cylinder

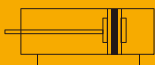

Specifications

Bore(mm)	6	10	16	20
Acting type	Double Acting			
Working medium	Clean Air(40 μ m filtration)			
Working pressure (MPa)	0.15~0.7			
Guaranteed pressure (MPa)	1.05			
Working temperature (°C)	-20~70(No freezing)			
Speed range (mm/s)	50~500			
Cushion type	Rubber cushion			
Stroke tolerance(mm)	+1.0 0			
Allowable kinetic energy(J)	0.008	0.025	0.05	0.1
Port size	M5 × 0.8			

How to Order?

Series No	Bore	X	Stroke	-	Magnet No
EXH	6		5		S : With magnet
	10		10		
	16		15		
	20		...		

Order Example:

EXH series, linear bearing, bore 6mm, stroke 10mm,
ERP code is: EXH6X10-S

Stroke

Bore (mm)	Standard Stroke (mm)	Max. Stroke (mm)
6	5 10 15 20 25 30 40	40
10	5 10 15 20 25 30 40 50	50
16	5 10 15 20 25 30 40 50 60	60
20	5 10 15 20 25 30 40 50 60	60

Optional Accessories

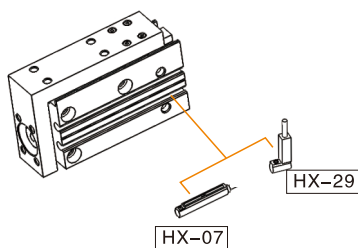

Note: Short stroke please use HX-29 series due to limited space.

How to Mount ?

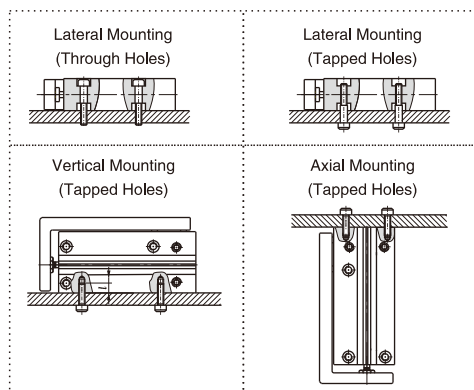

Internal Structure

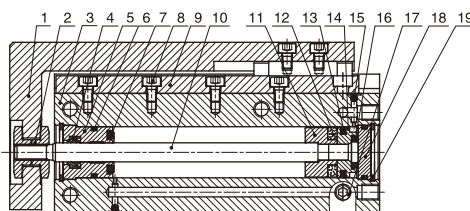

No.	Part Name	Material
1	Slide Table	Aluminum alloy
2	Locknut	Carbon steel
3	Body	Aluminum alloy
4	Front Scraper Seal	NBR
5	Head cover	Aluminum alloy
6	O-ring	NBR
7	Bumper	TPU
8	Screws	Carbon steel
9	Linear ball slide rail	Stainless steel
10	Piston rod	Stainless steel
11	Magnet seat	Aluminum alloy
12	Magnet	Neodymium iron boron
13	Piston seal	NBR
14	Piston	Aluminum alloy
15	Steel ball	Stainless steel
16	Bumper	TPU
17	Plug	Cu
18	Rear cover	Aluminum alloy
19	C clip	Spring steel

Model Selection Method

1. Cylinder theoretical force confirmation: Select the bore size according to the thrust and practicality, refer to the below table.
2. Determine the selection conditions in order, starting from the upper row in the table below, and choose one of the selection graphs to be used.

	Vertical			Horizontal								
Mounting position												
Maximum Speed (mm/s)	≤100	≤300	≤500	≤100			≤300			≤500		
Load eccentricity (mm)	-	-	-	50	100	200	50	100	200	50	100	200
Selection graph	(1)	(2)	(3)	(4)	(5)	(6)	(7)	(8)	(9)	(10)	(11)	(12)

Note: L can also be the angular distance between the load centre of gravity and the cylinder shaft centre as shown in the right figure.

2.1 The relation between loading and overhang (Selection graphs)

Graph (1) Maximum Speed ≤100 (mm/s)

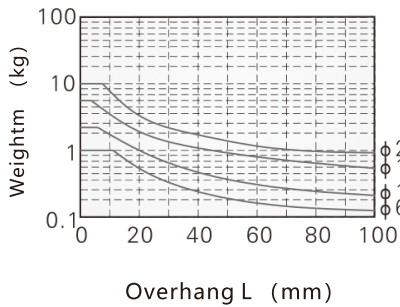

Graph (2) Maximum Speed ≤300 (mm/s)

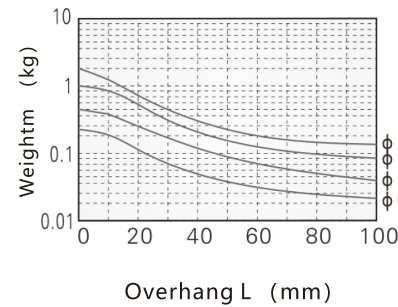

Graph (3) Maximum Speed ≤500 (mm/s)

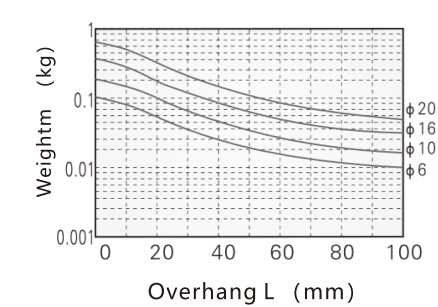

Graph (4) Maximum Speed ≤100 (mm/s)
Load eccentricity: 500 (mm)

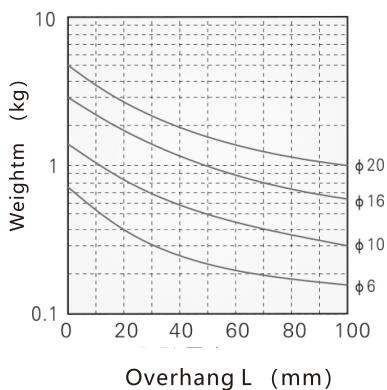

Graph (5) Maximum Speed ≤100 (mm/s)
Load eccentricity: 100 (mm)

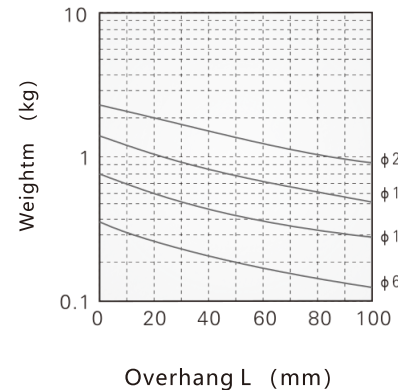

Graph (6) Maximum Speed ≤100 (mm/s)
Load eccentricity: 200 (mm)

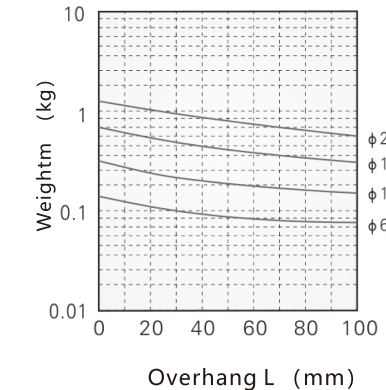

EXH Series Compact Slide Cylinder



Model Selection Method

Graph (7) Maximum Speed ≤ 300 (mm/s)
Load eccentricity: 50 (mm)

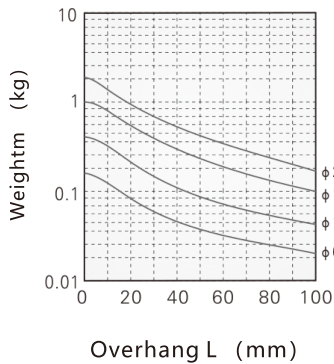

Graph (8) Maximum Speed ≤ 300 (mm/s)
Load eccentricity: 100 (mm)

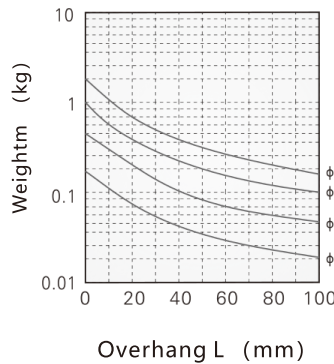

Graph (9) Maximum Speed ≤ 300 (mm/s)
Load eccentricity: 200 (mm)

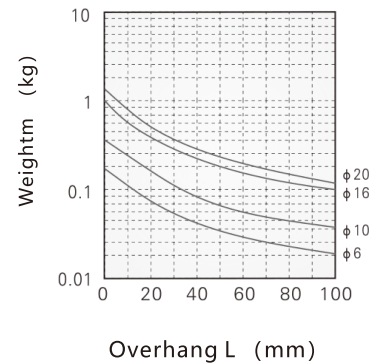

Graph (10) Maximum Speed ≤ 500 (mm/s)
Load eccentricity: 50 (mm)

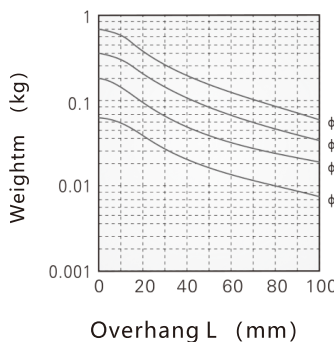

Graph (11) Maximum Speed ≤ 500 (mm/s)
Load eccentricity: 100 (mm)

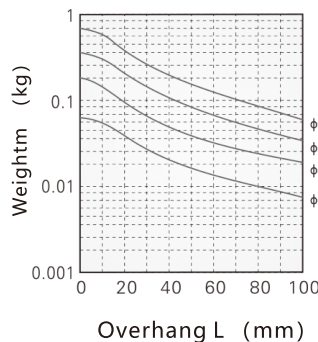

Graph (12) Maximum Speed ≤ 500 (mm/s)
Load eccentricity: 200 (mm)

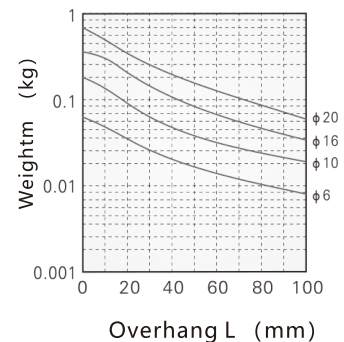

2.2 Selection example

Example 1: Mounting: Vertical

Maximum Speed: 500 mm/s

Overhang: 40 mm

Load weight: 0.1 kg

Refer to Graph 3 base on vertical mounting and a speed of 500 mm/s

In graph 3, find the intersection of a 40 mm overhang and load weight of 0.1 kg, which results in a selection of $\Phi 20$

Example 2: Mounting: Horizontal

Maximum Speed: 500 mm/s

Load eccentricity: 50 mm

Overhang: 30 mm

Load weight: 0.1 kg

Refer to Graph 10 base on horizontal mounting and a speed of 500 mm/s and load eccentricity of 50 mm.

In graph, find the intersection of a 30 mm overhang and load weight of 0.1 kg, which results in a selection of $\Phi 16$.

Installation and application

1. The actual loading and torque of cylinder must be less than its allowable loading and torque:

1.1 The allowable moment of cylinder

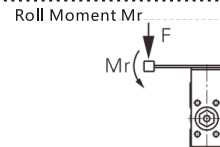
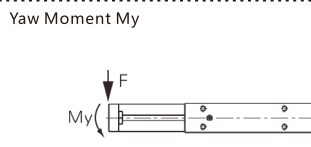
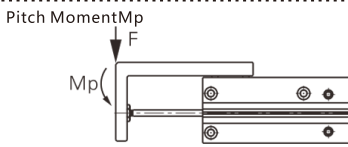

Model	Allowable torque(N.m)		
	Pitch Moment Mp	Yaw Moment My	Roll Moment Mr
EXH6	0.25	0.25	0.41
EXH10	0.95	0.95	1.49
EXH16	3.28	3.28	3.45
EXH20	6.29	6.29	6.61

1.2 When the cylinder is subjected to different type of torque, there will be different degree of shift in performance, please refer to the following table for details.

Table deflection due to Pitch Moment

Table deflection (arrow) when a load acts upon the section marked with the arrow at the full stroke of the compact slide

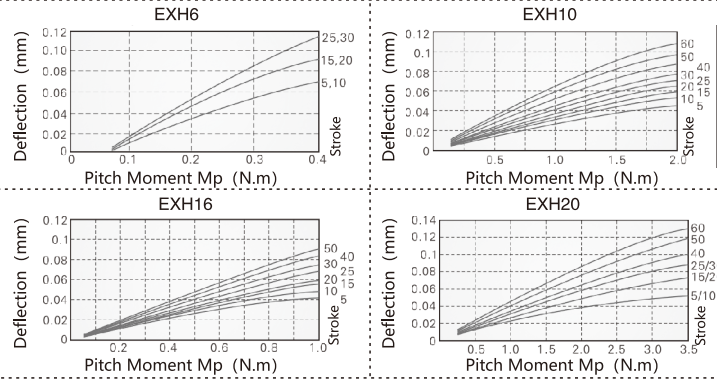
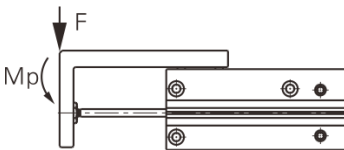

Table deflection due to Yaw Moment

Table deflection (arrow) when a load acts upon the section marked with the arrow at the full stroke of the compact slide

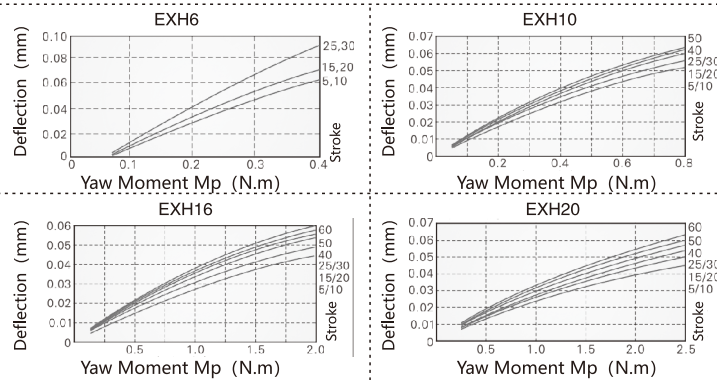
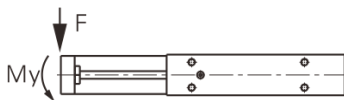
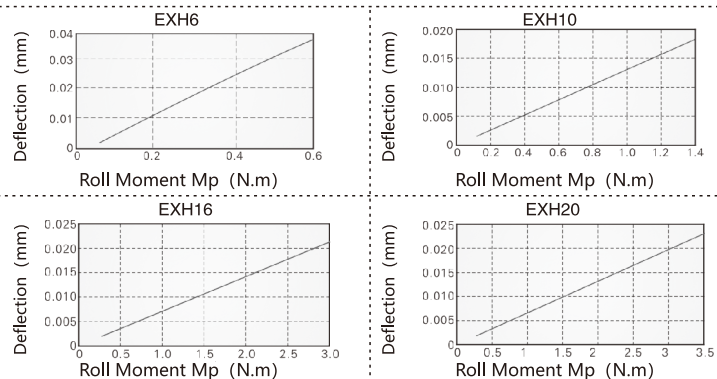
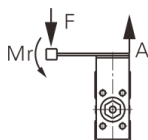

Table deflection due to Roll Moment

Table deflection (at A) when a load acts upon section F at the full stroke of the compact slide.



EXH Series Compact Slide Cylinder



Installation and Application

2. The compact slide can be piped in 3 directions. Confirm the pressure ports and operating direction. (See drawing right);

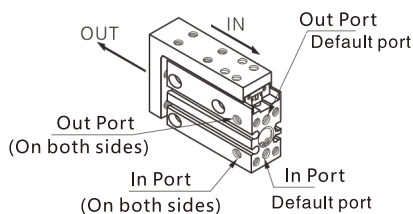

3. In compact slides with sensor switch, there is a danger of sensor switch malfunction if the mounting pitch is less than the dimensions shown in Table right. Be sure to allow at least the indicated interval.

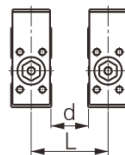

Model	At least indicated interval (mm)	
	d	L
EXH6	5	21
EXH10	5	25
EXH16	10	35
EXH20	15	47

4. When the output of the compact slide will be directly applied to the table, it should be applied along the rod axis. (See drawing below)

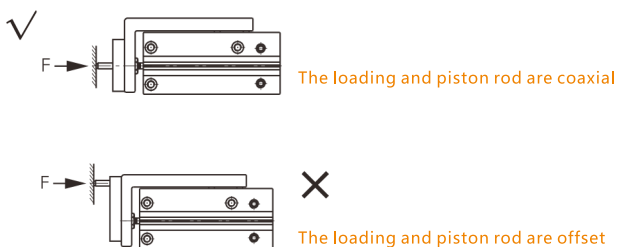

5. Be sure to use a flow control valve, and adjust the speed to 500mm/s or less.
6. A compact slide can be mounted from 4 directions. Don't exceed the max. fastening torque to tighten the mounting bolts.

Lateral Mounting (Through Holes)

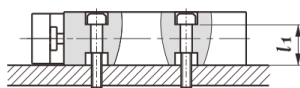

Lateral Mounting (Tapped Holes)

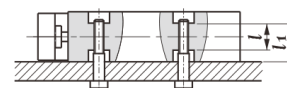

Model	Bolts	Max. fastening torque	L1
EXH6	M3X0.5	1.1 (Nm)	12.7
EXH10	M4X0.7	2.5 (Nm)	15.6
EXH16	M4X0.7	2.5 (Nm)	20.6
EXH20	M5X0.8	5.1 (Nm)	24

Model	Bolts	Max. fastening torque	L	L1
EXH6	M4X0.7	2.5 (Nm)	9.4	12.7
EXH10	M5X0.8	5.1 (Nm)	11.2	15.6
EXH16	M5X0.8	5.1 (Nm)	16.2	20.6
EXH20	M6X1.0	8.1 (Nm)	16	24

Vertical Mounting (Tapped Holes)

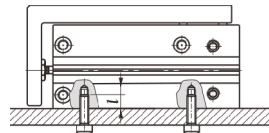

Axial Mounting (Tapped Holes)

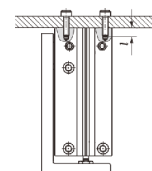

Model	Bolts	Max. fastening torque	L
EXH6	M3X0.5	1.1 (Nm)	5
EXH10	M4X0.7	2.5 (Nm)	6
EXH16	M4X0.7	2.5 (Nm)	6
EXH20	M5X0.8	5.1 (Nm)	8

7. Work Piece Mounting:

7.1 Work pieces can be mounted on 2 surfaces of the compact slide. When mounting a work piece, tighten the bolts at a torque value within the limiting range.

When mounting a work piece on top of the table, do not screw the bolt deeper than the thread length in the table (See below table L), otherwise the bolt will damage the linear guide.

Front Mounting

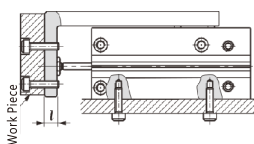

Model	Bolts	Max. fastening torque	L
EXH6	M3X0.5	1.1 (Nm)	5.5
EXH10	M4X0.7	2.5 (Nm)	7.5
EXH16	M4X0.7	2.5 (Nm)	10
EXH20	M5X0.8	5.1 (Nm)	11

Top Mounting

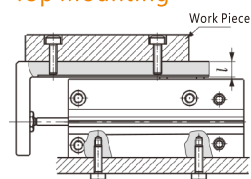

Model	Bolts	Max. fastening torque	L
EXH6	M3X0.5	1.1 (Nm)	6.5
EXH10	M4X0.7	2.5 (Nm)	8
EXH16	M4X0.7	2.5 (Nm)	9
EXH20	M5X0.8	5.1 (Nm)	9.5

7.2 Since the table is supported by the linear guide, take care not to apply strong impact or large moment to the guide section.

7.3 Hold the slide when fastening work pieces with bolts, if the body is held while tightening bolts, excessive moment may damage guide section.

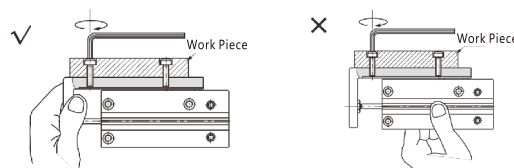

Hold the slide and fasten the bolt

Hold the body and fasten the bolt

EXH Series Compact Slide Cylinder



Main Dimension

EXH $\Phi 6$

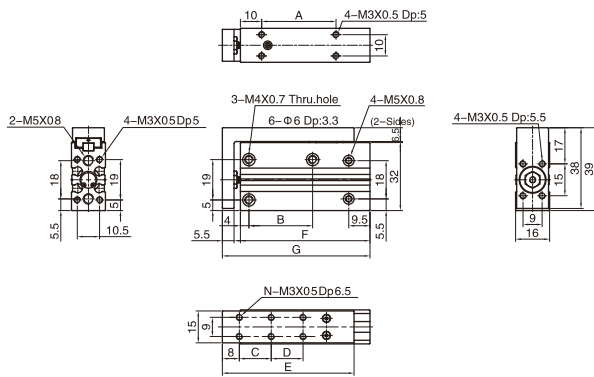

(mm)								
Bore\Sign	N	A	B	C	D	E	F	G
5	4	10	14	10	-	42	36	44.5
10	4	15	14	10	-	42	41	49.5
15	4	20	24	20	-	52	46	54.5
20	4	25	24	20	-	52	51	59.5
25	4	30	30	30	-	62	56	64.5
30	4	35	30	30	-	62	61	69.5
40	6	45	45	20	20	72	71	79.5

EXH $\Phi 10$

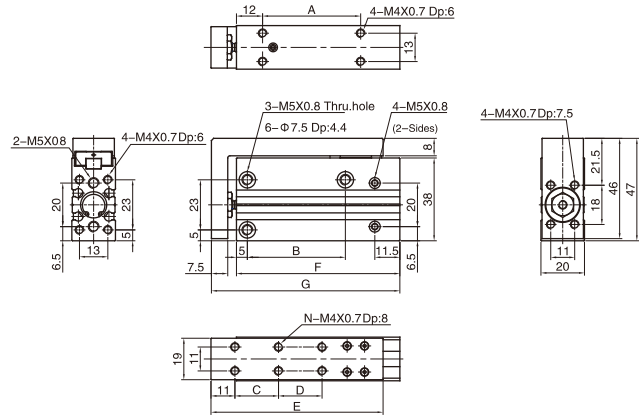

(mm)								
Bore\Sign	N	A	B	C	D	E	F	G
5	4	10	14	10	-	49	40	51.5
10	4	15	14	10	-	49	45	56.5
15	4	20	24	20	-	59	50	61.5
20	4	25	24	20	-	59	55	66.5
25	4	30	30	30	-	69	60	71.5
30	4	35	30	30	-	69	65	76.5
40	6	45	45	20	20	79	75	86.5
50	6	55	55	25	25	89	85	96.5

EXH $\Phi 16$

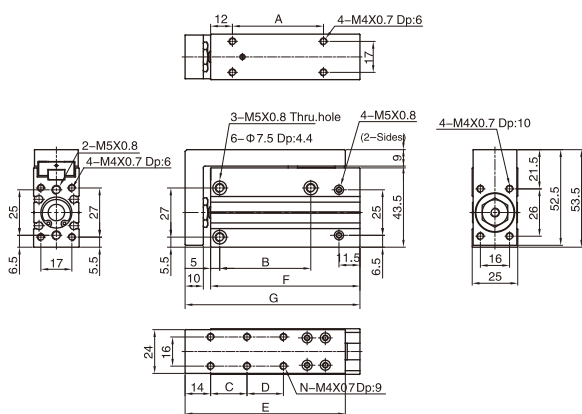

(mm)								
Bore\Sign	N	A	B	C	D	E	F	G
5	4	15	20	10	-	58	47	61
10	4	20	20	10	-	58	52	66
15	4	25	30	20	-	68	57	71
20	4	30	30	20	-	68	62	76
25	4	35	40	30	-	78	67	81
30	4	40	40	30	-	78	72	86
40	6	50	50	20	20	88	82	96
50	6	60	60	25	25	98	92	106
60	6	70	60	30	30	108	102	116

EXH $\Phi 20$

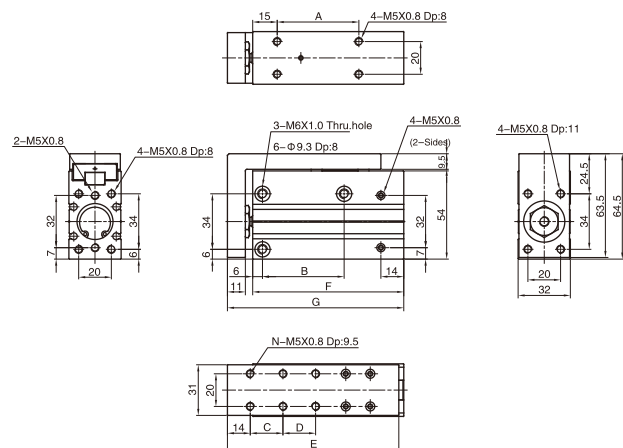

(mm)								
Bore\Sign	N	A	B	C	D	E	F	G
5	4	15	20	10	-	64	57.5	73
10	4	20	20	10	-	64	62.5	78
15	4	25	25	20	-	74	67.5	83
20	4	30	25	20	-	74	72.5	88
25	4	35	40	30	-	84	77.5	93
30	4	40	40	30	-	84	82.5	98
40	6	50	50	20	20	94	92.5	108
50	6	60	70	25	25	104	102.5	118
60	6	70	70	30	30	114	112.5	128