

SHY Air Gripper

SHYSA: Magnetic, single-acting normally open type



SHY: Magnetic, double-acting type, with its own throttle valve



Specifications

Bore size(mm)		10	16	20	25
Acting type		Double Acting/Single Acting			
Working medium		Clean Air(40 μ m filtration)			
Applicable pressure range	Double acting	Φ 10	0.15~0.7MPa(22~100psi)(1.5~7.0bar)		
		Φ 16~Φ 25	0.1~0.7MPa(15~100psi)(1.0~7.0bar)		
	Single acting	Φ 10	0.3~0.7MPa(45~100psi)(3.0~7.0bar)		
		Φ 16~Φ 25	0.25~0.7MPa(36~100psi)(2.5~7.0bar)		
Working temperature		-20~70℃(No freezing)			
Oil		Not required			
Maximum frequency		180(C.P.M)			
Port size		M3X0.5		M5X0.8	
Weight(g)		42	94	174	303

How to Order?

Series	Type No.	Bore	Magnet No.
SHY:Y type gripper	Blank: Basic type SA: Single acting (N.O.)	10 16 20 25	S : With magnet (Magnet is standard)

Order Example:

SHY Series Air Gripper, Bore25, with magnet, ERP code is: SHY25-S

Product Features

1. Single piston structure, large gripping torque.
2. Integrated with variable throttle valve, easy to adjust the gripping jaw opening & closing speed.
3. Reasonable gripping angle, wide range of application.
4. Accurate positioning accuracy, it is more accurate and reliable when gripping workpiece.
5. Multi mounting type, convenient for use in different application.
6. All series with magnet, easy to control.

Optional Accessories

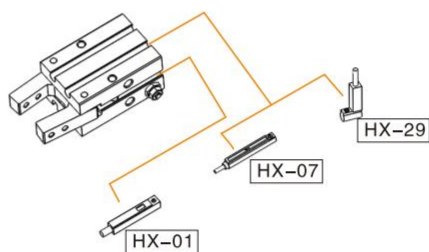

Theoretical Clamping Torque

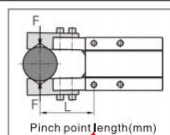

Acting type	Type	Theoretical clamping moment(N · cm)		Max pinch point length (L)(mm)	Open angle	Closure angle
		Closure clamping torque	Open clamping torque			
Double acting	SHY10	17.6XP	29.4XP	30	30°	-10°
	SHY16	90XP	129XP	40		
	SHY20	152XP	252XP	60		
	SHY25	304XP	473XP	70		
	SHYSA10	11.8XP	-	30		
Single acting (N.O.)	SHYSA16	71.2XP	-	40		
	SHYSA20	122.4XP	-	60		
	SHYSA25	252XP	-	70		

Note: In the above table, "P" represents the actual use of pneumatic pressure, "P" unit: Mpa

Internal Structure

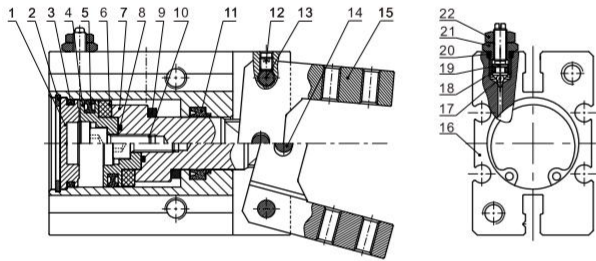

No.	Part Name	Material	No.	Part Name	Material
1	Rear cover	Aluminum alloy	12	Hexagon socket set screw	Carbon steel
2	C type retainer ring	Spring steel	13	Pin	Stainless steel
3	O-ring	NBR	14	Pin	Stainless steel
4	Piston	Aluminum alloy/Stainless steel (Φ10)	15	Claw	Cast steel
5	Piston seal	NBR	16	Barrel	Aluminum alloy
6	Magnet	Plastic	17	Steel ball	Stainless steel
7	Piston rod	Aluminum alloy/Stainless steel (Φ10, Φ16)	18	O-ring	NBR
8	O-ring	NBR	19	Buffer screw	Brass
9	Anti-bump cushion	PTEE	20	O-ring	NBR
10	Hexagon socket cap screw	Carbon steel	21	Buffer fixing screw	Brass
11	Piston rod seal	TPU/NBR(Φ25)	22	Hexagon nut	Carbon steel

Main Dimension

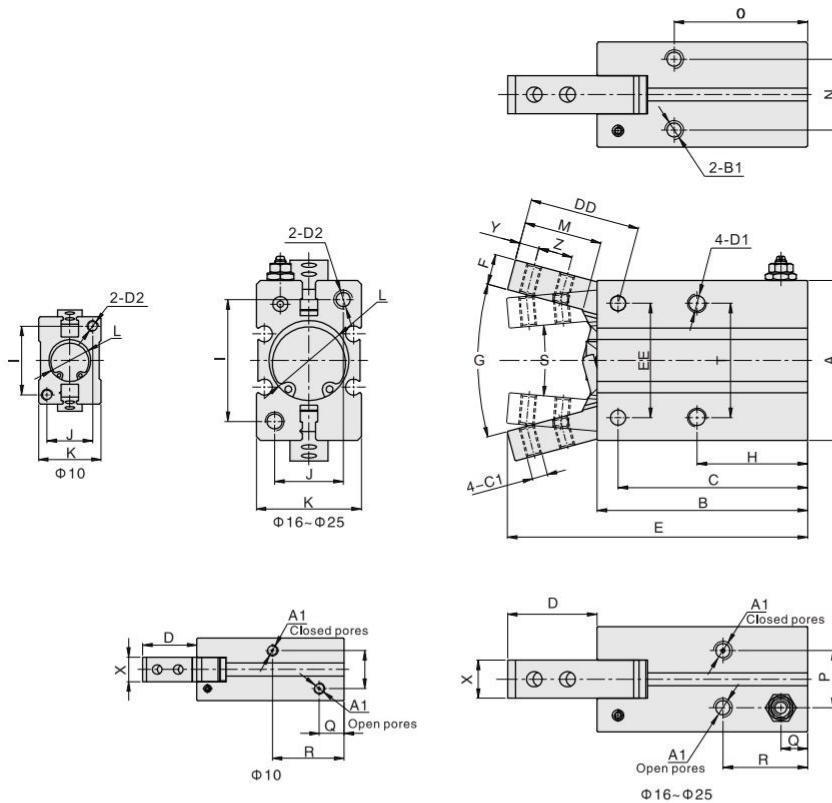

Bore/Sign	A	A1	B	B1	C	C1	D	DD	D1	D2	E	EE						
SHY10	23	M3X0.5	38.6	M3X0.5Depth6	35.8	M2.5X0.45	14.2	17.2	M3X0.5Depth6	M3X0.5Depth6	52.8	14						
SHY16	30.6	M5X0.8	44.6	M4X0.7Depth5.5	39.7	M3X0.5	18.9	23.6	M4X0.7Depth9.5	M4X0.7Depth8	63.5	24						
SHY20	42	M5X0.8	55.2	M5X0.8Depth8	49.7	M4X0.7	23.5	29	M5X0.8Depth11.5	M5X0.8Depth10	78.7	30						
SHY25	52	M5X0.8	60.4	M6X1.0Depth10	54.8	M5X0.8	32.8	38.5	M6X1.0Depth14.5	M6X1.0Depth12	93.2	36						
Bore/Sign	F	G	H	I	J	K	L	M	N	O	P	Q	R	S	T	X	Y	Z
SHY10	4	30°	23	18	12	16.4	Φ11Depth1.5	12.5	11.4	27	10	6.5	18.8	10°	16	7.4	3	5.7
SHY16	7	30°	24.5	22	15	23.6	Φ17Depth1.5	16.5	16	30	13	6.5	18.3	10°	24	10	4	7
SHY20	8	30°	29	32	18	27.6	Φ21Depth1.5	20.5	18.6	35	15	7	22.2	10°	30	12	5.2	9
SHY25	10	30°	30	40	22	33.6	Φ26Depth1.5	27.5	22	36.5	19.5	7.4	23.5	10°	36	12	8	12

Installation and Use

1. Installing a fall prevention device is recommended when applying a lowering clamping force. In the case of a sudden pressure decrease due to emergency stop, these prevention devices can help to avoid personal or equipment injuries.
2. Air grippers are not intended for use under strong external or heavy impact forces.
3. When installing or repairing your air gripper take precautions to safely use your component.
4. Don't reverse the clamping gripper when installing clamping parts.
5. The locking torque of the fastening screw must be within the prescribed torque range shown in the chart below. If the locking torque is not set properly the unit will not perform correctly.

Tail Mounting Type

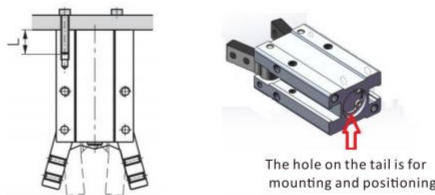

Bore	Bolt Size	Max.Locking Torque (Nm)	Max.Screwed Depth (mm)	Tail Positioning Bore Dia(mm)	Tail positioning Depth(mm)
10	M3X0.5	0.88	6	φ 11H9	1.5
16	M4X0.7	2.1	8	φ 17H9	1.5
20	M5X0.8	4.3	10	φ 21H9	1.5
25	M6X1.0	7.3	12	φ 26H9	1.5

Front Tapped Hole Mounting

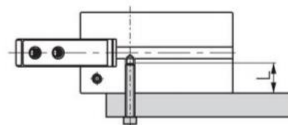

Bore	Bolt Size	Max.Locking Torque (Nm)	Max.Screwed Depth (mm)
10	M3X0.5	0.69	5
16	M4X0.7	2.1	8
20	M5X0.8	4.3	10
25	M6X1.0	7.3	12

Through Hole Mounting

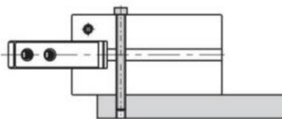

Bore	Bolt Size	Max.Locking Torque (Nm)	Max.Screwed Depth (mm)
10	M2.5X0.45	0.49	5
16	M3X0.5	0.88	8
20	M4X0.7	2.1	10
25	M5X0.8	4.3	12

Side Tapped Hole Mounting

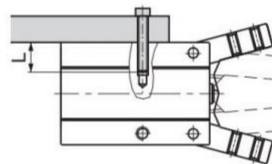

Bore	Bolt Size	Max.Locking Torque (Nm)	Max.Screwed Depth (mm)
10	M3X0.5	0.88	6
16	M4X0.7	1.6	6.5
20	M5X0.8	3.3	8
25	M6X1.0	5.9	10

6. Clamping Jaw Installation:

Never clamp the body directly and then lock the screws. The gripping jaw should be held by the spanner and the screw should be locked using a hex wrench.

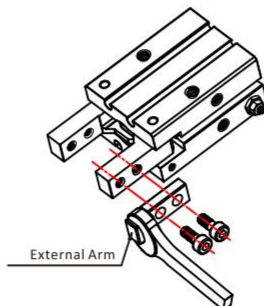

Bore	Bolt Size	Max.Locking Torque (Nm)
10	M2.5X0.45	0.31
16	M3X0.5	0.59
20	M4X0.7	1.4
25	M5X0.8	2.8

7. When gripping an object, the item must be placed in the centre of the two gripping jaws, and the two gripping jaws should touch the object at the same time.
8. Avoid applying external forces to the gripping jaw. Always leave enough space to adequately grip and place your object. The gripper should be free moving.
9. When gripping an object the item should always be centred. When testing, you must reduce the pressure for low speed running, to guarantee the safety and no impact.
10. Please use the flow control valve to adjust the opening and closing speed of your gripper.
11. Always ensure the gripper path is clear of obstruction.
12. Before removing your air gripper, please make sure all power is disconnected and you've discharged residual compressed air.